

WENTYLATORY KANAŁOWE

Ø560 Ø630

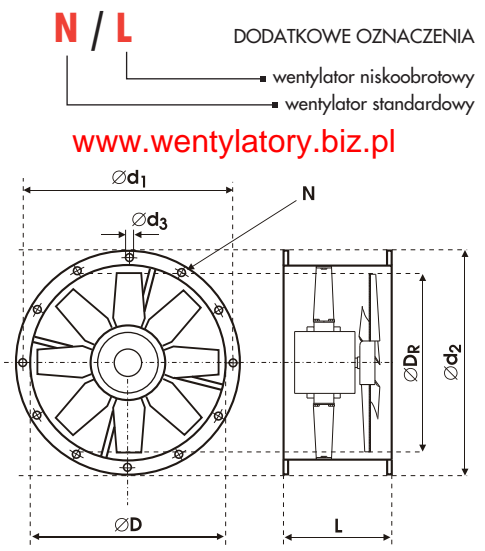
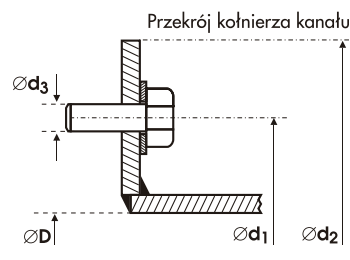
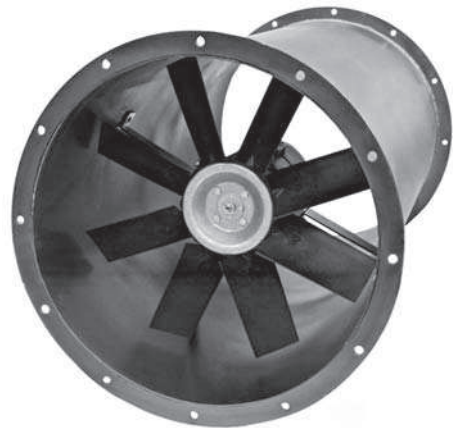

www.wentylatory.biz.pl

	d ₃	d ₁ mm	d ₂ mm	D _R mm	D mm	L mm	Liczba otworów N
0560	M12	629	664	550	560	450	16
0630	M12	698	734	620	630	450	16

TYP WENTYLATORA	PRĘDKOŚĆ OBROTOWA (min ⁻¹)	WYDAJNOŚĆ (m ³ h)	MOC (kW)	PRĄD (A)	IP	MAX. TEMP. PRACY (°C)	MASA (kg)	CIŚNIENIE AKUSTYCZNE SPL dB(A)	MOC AKUSTYCZNA Lw dB(A)	TYP REGULATORA
1 560/KAN/8-8/40/400/N	1400	11200	0,75	2,2	66	60	33	69	80	FT-4,1 / FJ-6,0
2 560/KAN/10-10/45/400/N	1400	13800	1,1	3,0	66	60	34	74	85	FT-4,1 / FJ-6,0
3 560/KAN/12-12/50/400/N	1400	15200	1,5	4,3	66	60	36	76	87	FT-5,4 / FJ-9,6
4 630/KAN/12-12/45/400/L	900	12200	0,55	2,3	66	60	35	67	78	FT-4,1 / FJ-6,0
5 630/KAN/10-10/45/400/N	1400	18100	1,5	4,3	66	60	39	75	86	FT-5,4 / FJ-9,6
6 630/KAN/12-12/50/400/N	1400	21000	2,2	5,80	66	60	43	79	90	FT-6,9

i Możliwość wykonania wentylatorów w wersji PT (podwyższona temperatura pracy).

CHARAKTERYSTYKI WENTYLATORÓW

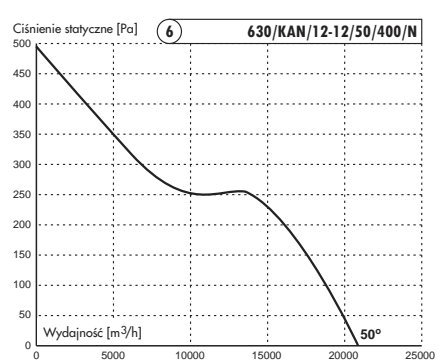
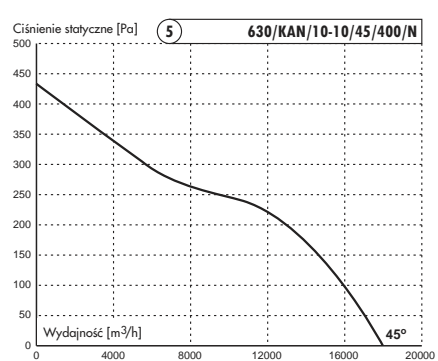
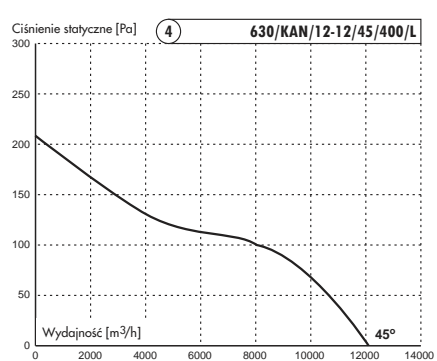
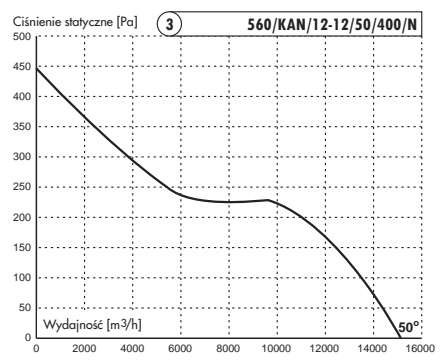
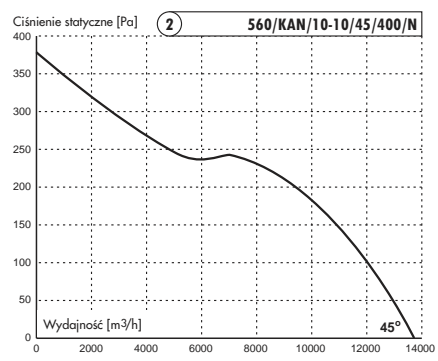
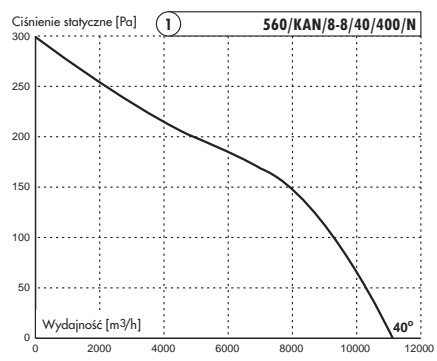

PRZEDSIĘBIORSTWO HANDLOWO USŁUGOWE

tel 609 293 502