

WENTYLATORY KANAŁOWE

Ø400

N / H

DODATKOWE OZNACZENIA

- wentylator wysokoobrotowy
- wentylator standardowy

www.wentylatory.biz.pl

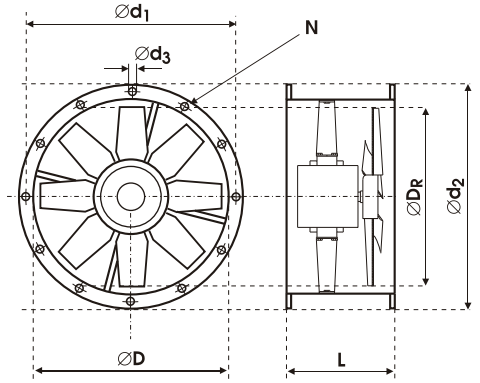
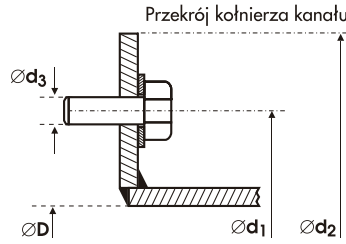
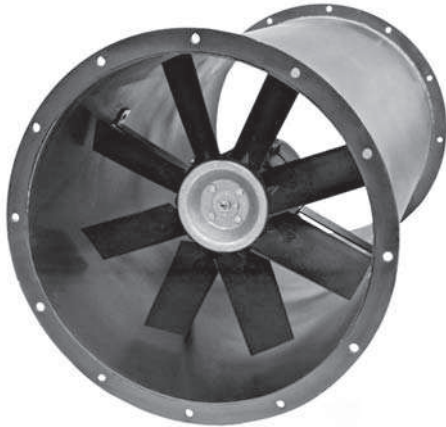

d ₃	d ₁ mm	d ₂ mm	D _R mm	D mm	L mm	Liczba otworów N
M10	448	500	390	400	450	12

TYP WENTYLATORA	PRĘDKOŚĆ OBROTOWA (min ⁻¹)	WYDAJNOŚĆ (m ³ h)	MOC (kW)	PRĄD (A)	IP	MAX. TEMP. PRACY (°C)	MASA (kg)	CIŚNIENIE AKUSTYCZNE SPL dB(A)	MOC AKUSTYCZNA Lw dB(A)	TYP REGULATORA
1 400/KAN/10-10/50/230/N	1350	5530	0,37	2,8	66	60	23	66	77	SPA-3
2 400/KAN/10-10/50/400/N	1400	5730	0,37	1,2	66	60	22	66	77	FT-1,2 / FJ-3,5
3 400/KAN/12-12/50/230/N	1350	5320	0,37	2,8	66	60	22	65	76	SPA-3
4 400/KAN/12-12/45/400/N	1400	5110	0,37	1,2	66	60	23	64	75	FT-1,2 / FJ-3,5
5 400/KAN/8-8/30/400/H	2800	7120	1,1	2,5	66	60	25	71	82	FT-4,1 / FJ-6,0
6 400/KAN/8-8/35/400/H	2800	8520	1,5	3,3	66	60	24	75	86	FT-4,1 / FJ-6,0

i Możliwość wykonania wentylatorów w wersji PT (podwyższona temperatura pracy).

CHARAKTERYSTYKI WENTYLATORÓW

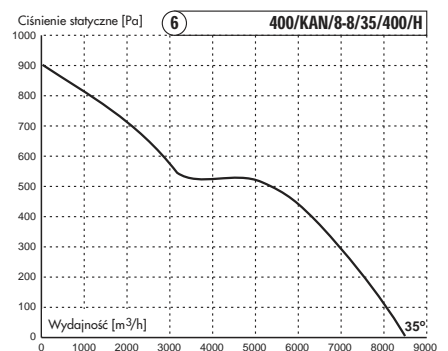
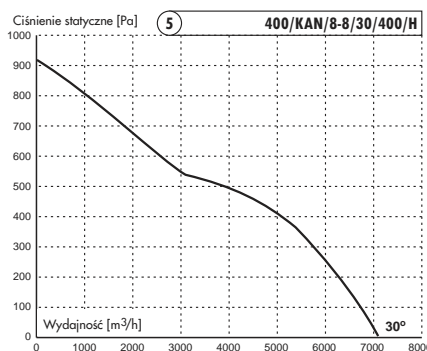
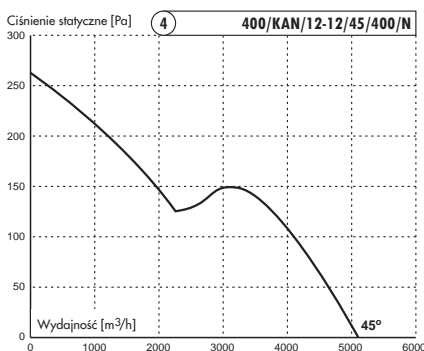
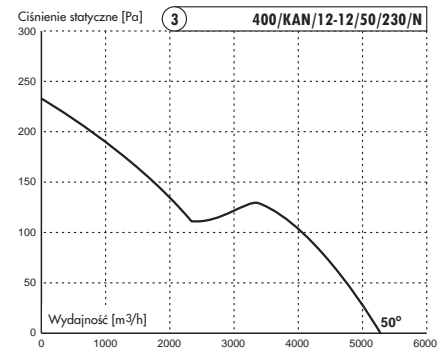
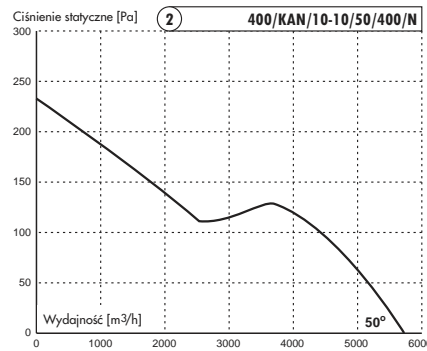
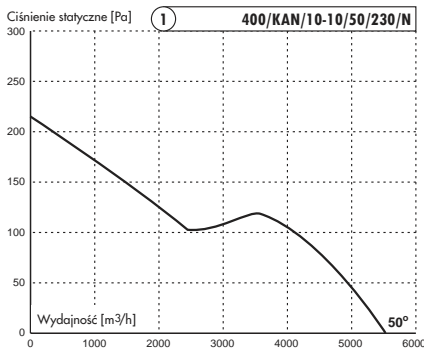

JiMwent

PRZEDSIĘBIORSTWO HANDLOWO USŁUGOWE

60-416 Poznań, ul. Olsztyńska 10, NIP 783-109-77-98

tel. 609 293 502