

# WENTYLATORY KANAŁOWE

Ø500

N / H

DODATKOWE OZNACZENIA

- wentylator wysokoobrotowy
- wentylator standardowy

[www.wentylatory.biz.pl](http://www.wentylatory.biz.pl)

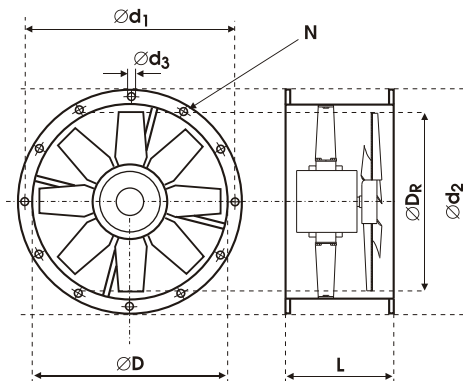
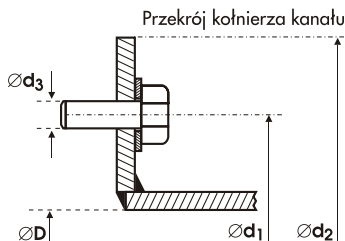
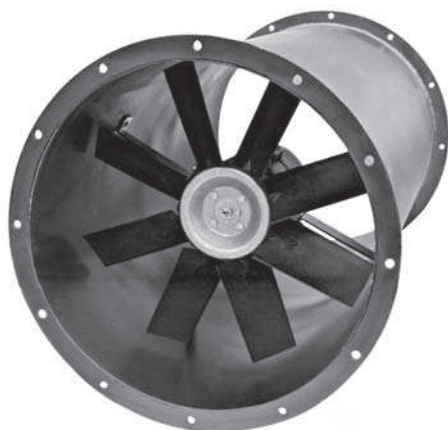

d <sub>3</sub>	d <sub>1</sub> mm	d <sub>2</sub> mm	D <sub>R</sub> mm	D mm	L mm	Liczba otworów N
M10	551	604	490	500	450	12

TYP WENTYLATORA	PRĘDKOŚĆ OBROTOWA (min <sup>-1</sup> )	WYDAJNOŚĆ (m <sup>3</sup> h)	MOC (kW)	PRĄD (A)	IP	MAX. TEMP. PRACY (°C)	MASA (kg)	CIŚNIENIE AKUSTYCZNE SPL dB(A)	MOC AKUSTYCZNA Lw dB(A)	TYP REGULATORA
1 500/KAN/8-8/45/230/N	1350	9470	0,55	4,0	66	60	29	69	80	SPA-5
2 500/KAN/8-8/40/400/N	1400	8620	0,55	1,3	66	60	30	67	78	FT-2,1 / FJ-3,5
3 500/KAN/10-10/50/230/N	1350	10500	0,75	5,1	66	60	29	72	83	SPA-10
4 500/KAN/10-10/45/400/N	1400	10100	0,75	2,2	66	60	30	71	82	FT-4,1 / FJ-6,0
5 500/KAN/8-8/30/400/H	2800	12300	2,2	4,8	66	60	31	75	86	FT-5,4 / FJ-9,6
6 500/KAN/8-8/35/400/H	2800	15100	3,0	6,9	66	60	35	80	91	FT-6,9

**i** Możliwość wykonania wentylatorów w wersji PT (podwyższona temperatura pracy).

## CHARAKTERYSTYKI WENTYLATORÓW

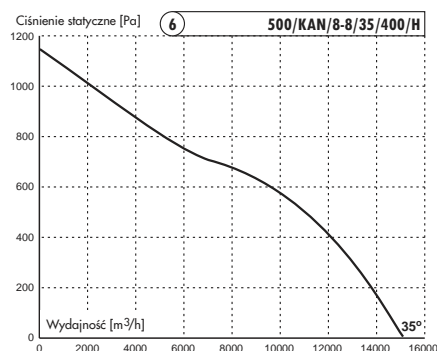
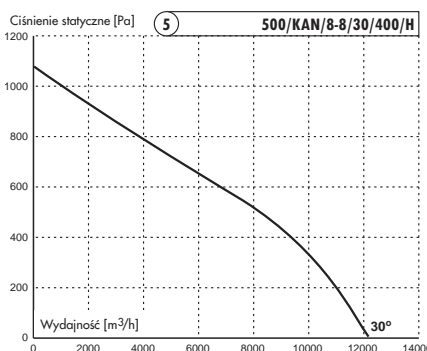
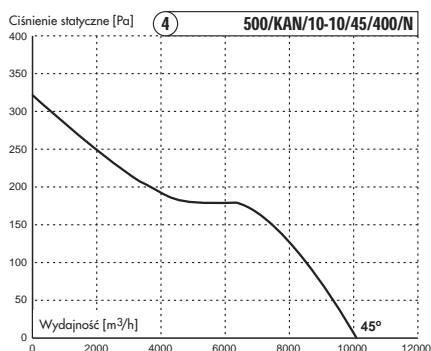
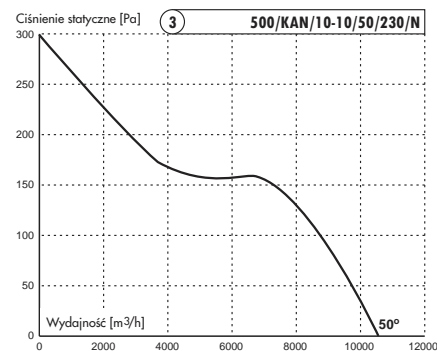
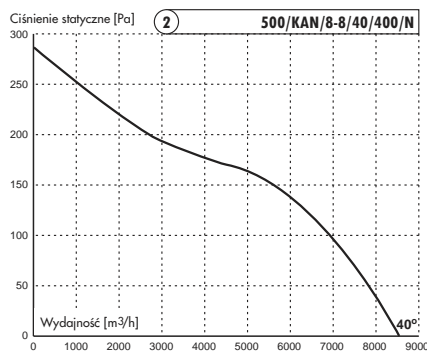
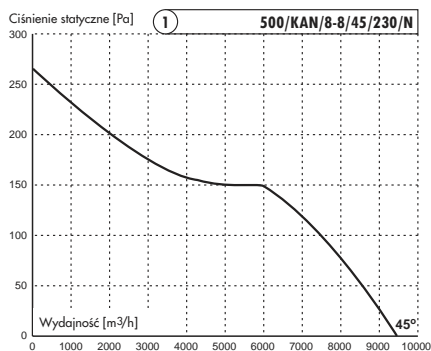

PRZEDSIĘBIORSTWO HANDLOWO USŁUGOWE

tel 609 293 502

60-416 Poznań, ul. Olsztyńska 10, NIP 783-109-77-98

0500

WENTYLATORY  
KANALOWE